

AM · PM

SENSATION

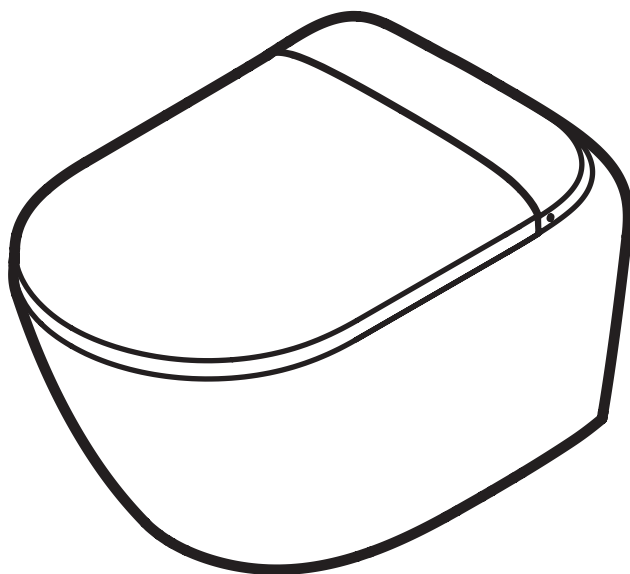



## Safety precautions

Please read the instructions carefully before installation and keep them available for future reference.

Follow all safety precautions and warnings to prevent any personal injury.

	<b>Attention</b>	Follow all safety precautions and warnings to prevent any personal injury.
	<b>Warning</b>	Improper handling can result in death or serious injury.

## Designation of the symbols

Symbol	Designation
	Prohibited actions
	Mandatory actions

### **Attention!**

	Never disassemble, repair, or make any technical changes to the product to prevent electric shock.
	Do not wash electronic parts and power cord with water or detergents to prevent fire and electric shock.
	Do not touch the plug with wet hands to prevent electric shock.
	Do not plug other devices into the same outlet.
	Please do not bend or warp the nozzle with your hands or tools. This may result in deterioration or damage to the product.
	Please do not bend or warp the nozzle with your hands or tools. This may result in deterioration or damage to the product.
	Please use only tap or drinking water.
	Do not let your child stand on the seat cover or place heavy objects on it. Don't knock on the lid.
Do not damage the power cord or power plug. A defective mains cable shall be replaced by the manufacturer, service or qualified person to avoid risk.	

### Attention!

Please do not bend, twist, or damage the water supply hose. Otherwise, it may cause leakage.

Stop use of the product, if it is defective. Press power reset button, turn off the power, and close the water supply valve in the following cases:

- excessive heat, smoke;
- abnormal sound and smell;
- the product is damaged or cracked;
- the product is blocked.

Using a defective product may result in electric shock, personal injury, fire or leakage in the room.

Do not use any polishes, gasoline, detergents, hard brushes or other aggressive cleaning agents to clean the product lid or other plastic parts. This may cause a chemical reaction or crack.

Do not move the seat or lid. The product may fall and result in personal injury.

During a thunderstorm, it is strongly recommended to cut the device off.

During installation, repair, disassembly and cleaning of the product, cut off power and water supply.

This product should be used at voltage 220V-240V, 50/60Hz, and current not less than 10A. The mains plug shall be provided with an earthing switch or protection against current leakage, or a similar high-sensitivity switch (normal current sensitivity up to 10mA).

Provide ventilation equipment in the bathroom to prevent moisture. Do not install in rooms with high humidity or risk of wetting the product. Otherwise, it may result in electric shock or fire.

In case of any water leakage, close the water supply valve and call for service.

Insert the seat lid into the quick-release console on the front. Gently pull the seat lid and make sure the lid is installed securely. Following the instructions will help prevent injury and ensure proper operation of the product.

Disconnect power to the product before removing the lid.



### Mandatory operations

## Safety precautions

### Attention!

### Mandatory operations

If you are not going to use the product for a long time, please turn off the water supply valve, drain the water and turn off the power. Before using the product after a break, drain any stagnant water.

#### Mandatory use of PTR

The outlet shall be installed at least 0,5 m above the floor and away from the bathtub and shower to prevent leaks.

Disconnect power before cleaning and do not expose it to direct water.

Do not expose the product to direct sunlight.

Keep room temperature to prevent any damage due to freezing.

To prevent burns to users, the seat temperature will automatically decrease after 15 minutes of use.

Make sure that the power is turned off and that the water valve is shut off before removing the seat lid.

Pay special attention, if the product is used by a person with heart disease.

The product can be used by children from 8 years of age and older, persons with limited physical, tactile and mental abilities or with limited experience and knowledge, if they have been instructed on using the device in safe ways and are aware of the possible risks.

Do not let children play with the device

Avoid any cleaning and care done by the children without supervision.

A defective network cable shall be replaced by the manufacturer, customer service, or qualified person to avoid risk.

## Specifications

<b>Rated voltage</b>		220-240V~ 50-60Hz
<b>Power cable</b>		About 500 mm
<b>Cleaning device</b>	<b>Outlet water temperature range</b>	About 35°C-42°C or turn off the water temperature
	<b>Nominal water consumption</b>	4L/6L
<b>Seat surface temperature</b>		Room temperature – about 38°C
<b>Soft closing method of the cover and the seat (Some models do not have this function)</b>		Slow closing mechanism
		Remote control
		Auto sensing
		Foot sensing
<b>Rated power*</b>		1120W
<b>Max. power**</b>		1630W
<b>Indoor temperature</b>		3°C - 40°C
<b>Water temperature</b>		3°C - 35°C
<b>Water pressure</b>		0.1MPa (static pressure) 0.75MPa (static pressure)
<b>Waterproof grade</b>		IPX4
<b>Product size</b>		595x425x430mm
<b>Battery for remote control</b>		AAA (2pcs)







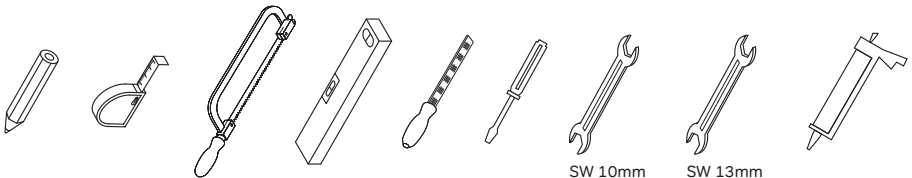
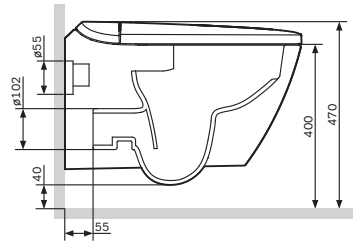
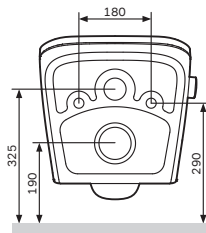
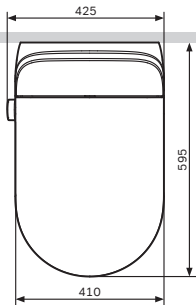
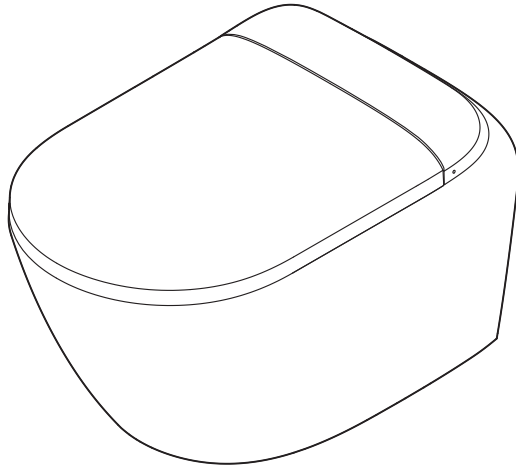



\* Rated power: The average power when the rear wash works for a cleaning cycle under the condition of ambient temperature 20°C±5°C, inlet water static pressure 0.18MPa, inlet water temperature 15°C±1°C and the water volume, seat temperature and water temperature set is set to the highest.

\*\* Maximum power: The maximum power at when the bidet wash works for a cleaning cycle under the condition of ambient temperature 23°C±2°C, inlet water static pressure 0.18MPa±0.02MPa, inlet water temperature 5°C±1°C and the water volume, seat temperature and water temperature set is set to the highest.

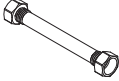
# Product Size

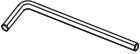

## Scope of delivery

<p><b>Remote control assembly</b></p>	
<p><b>Expansion screw set x2</b></p>	
<p><b>Nylon nut x2</b></p>	
<p><b>Ball valve</b></p>	
<p><b>Double-ended water inlet pipe</b></p>	
<p><b>Instruction manual</b></p>	
<p><b>Toilet mat</b></p>	
<p><b>Hexagon wrench</b></p>	
<p><b>Screw x2</b></p>	
<p><b>Decorative cover x2</b></p>	
<p><b>Gasket x2</b></p>	
<p><b>AAAx2</b></p>	

Part Name

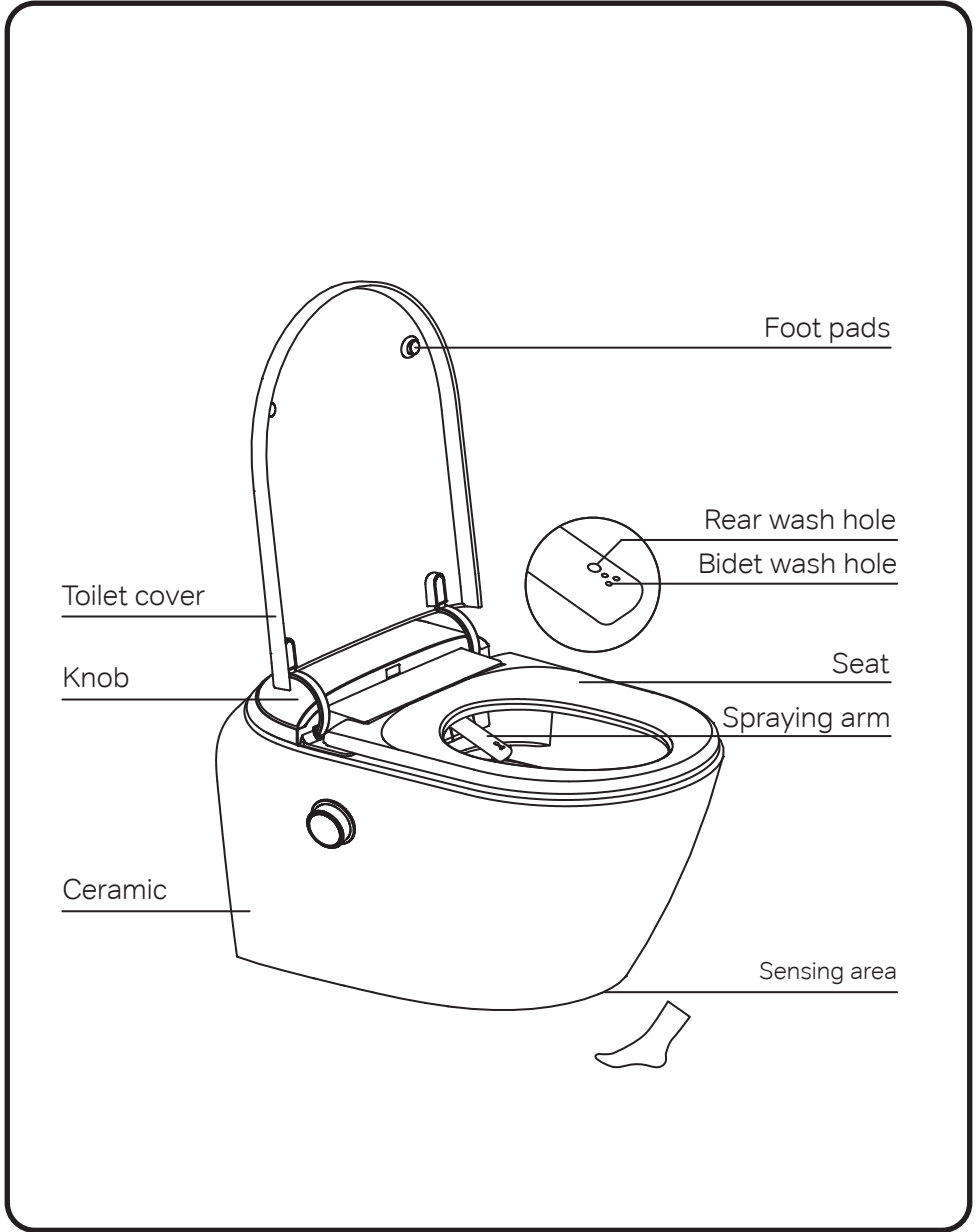

The manufacturer reserves the right to the final interpretation of this manual. Instructions are subject to change without notice. Product image may vary in color and appearance from the original.



1

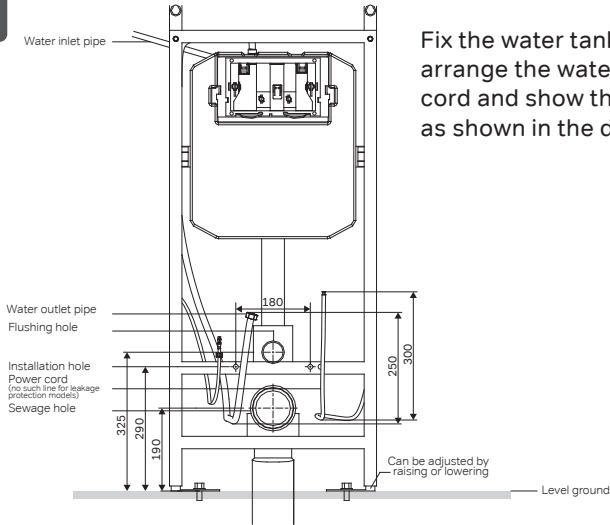

Fix the water tank frame. After fixing, arrange the water outlet pipe, power cord and show the dimensions as shown in the drawing.

2

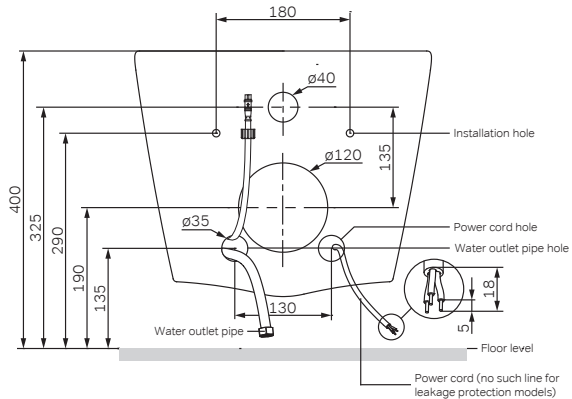

Put the toilet mat on the reserved position on the wall, direct the mounting hole of toilet mat to the fixed screw of the water tank frame, and then insert the mat, aligning with the flushing hole and sewage hole of the water tank, and pass the water outlet pipe through the water outlet hole, and the power cord passes through the power cord hole, exposed outside the wall.

## Installation instructions

3

The rear of the toilet is aligned with the toilet mat, and the outlet pipe, power cord, inserted into the toilet from the rear of the toilet. the flushing hole and sewage hole of the toilet are aligned with the corresponding position of the toilet mat. Move the toilet slowly towards the wall in the direction of the arrow until it is close to the wall.

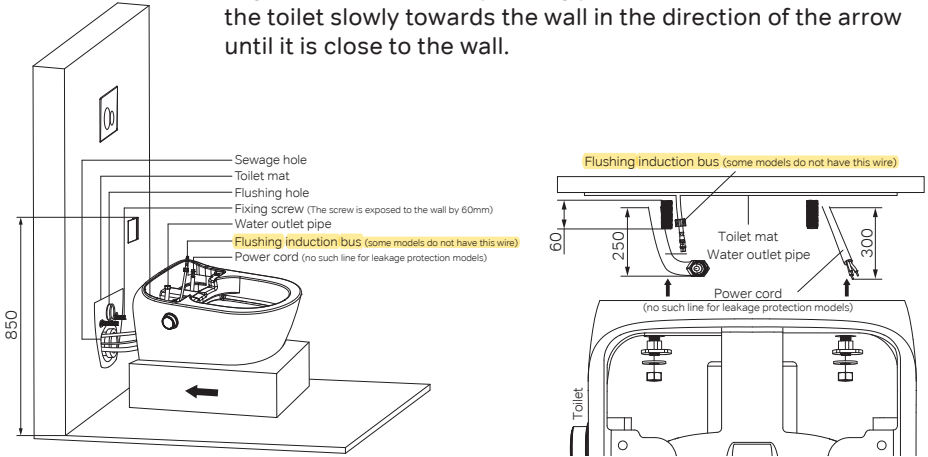

4

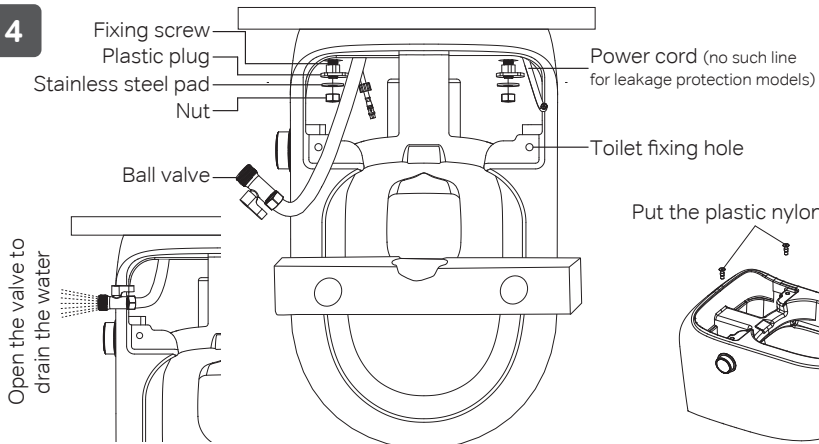

After the toilet is close to the wall, use a gradienter to measure the product to keep the product in a horizontal position. Then put a plastic plug and a stainless steel gasket on the fixed screw in turn, and then tighten the nut. Then connect the ball valve to the head of the outlet pipe and pass water to clear waste. Then put plastic nylon nut in the toilet fixing hole.

5

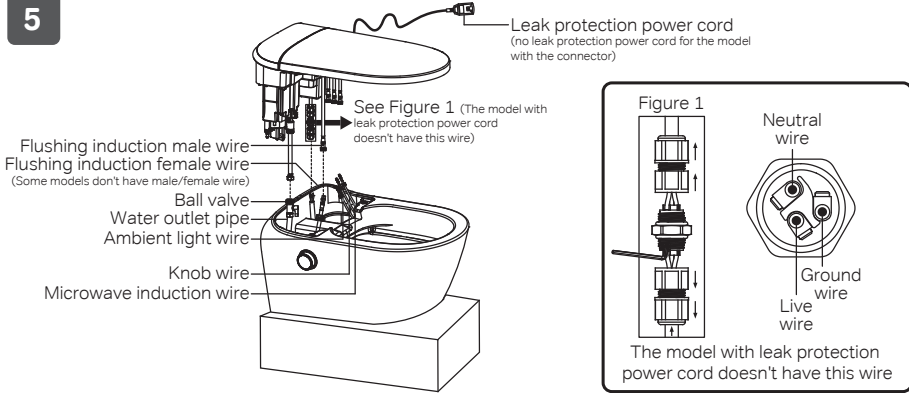

Install the power connector cable (no need to install the connector cable for the model with leakage protection plug), ambient light cable, knob cable, and microwave induction cable as shown in the figure. Note: When wiring, you need to disassemble the upper part of the waterproof plug, check whether the ground wire, neutral wire and live wire at both ends correspond to each other, and connect the power wire correctly.

6

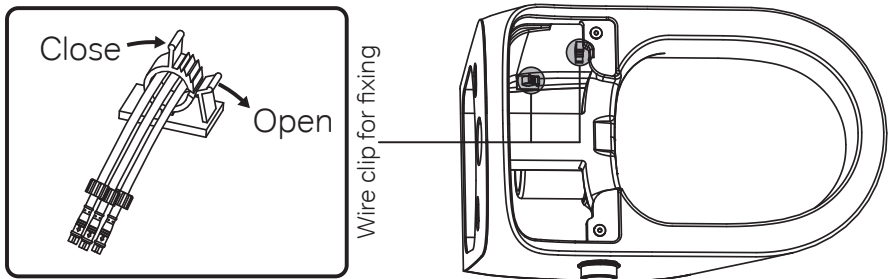

After the ambient light wire, knob wire and microwave induction wire are connected, arrange the wires and put them into the wire clip, and then press and hold the wire clip in the direction of closing indicated by the arrow. When you need to take out the wire, press the wire clip in the direction of opening indicated by the arrow.

## Installation instructions

7

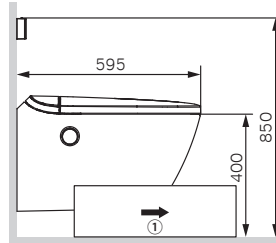

Standby/Descaling button

Filling port

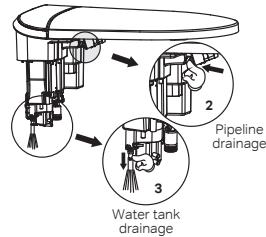
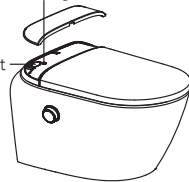

Fix the electronic seat on the top of ceramic, tighten it with the fixing screw, and install the decorative cover. After installation, take out the package in the direction of the arrow **1** in the figure. The remote control is installed at a distance of about 850mm from the ground, which is easy for users to remove it. When not in use for a long time, press in the direction of arrow **2** to drain the residual water in the pipe. Before replacement or maintenance, pls pull down according to the arrow **3** direction below, and drain the residual water inside the wank first.

### In the seated state (The light is always bright white):

1. Rotate the knob forward to activate the Bidet Wash function, and rotate the knob backward to activate the Rear Wash function.
2. Under the the function of Bidet Wash, Rear Wash or Drying, short press the knob to stop Bidet Wash, Rear Wash or Drying.
3. In the non-functional operation state, short press the knob to flush once.
4. Press and hold the knob to start Drying;
5. In the state of Bidet Wash or Rear Wash, rotate the knob forward or backward, and the nozzle moves forward or backward.
6. In the Drying state, rotate the knob forward to increase the air temperature, and rotate the knob backward to decrease the air temperature.

In the non-seated state (The light is white breathing light): short press the knob to flush once (without the function for some models).

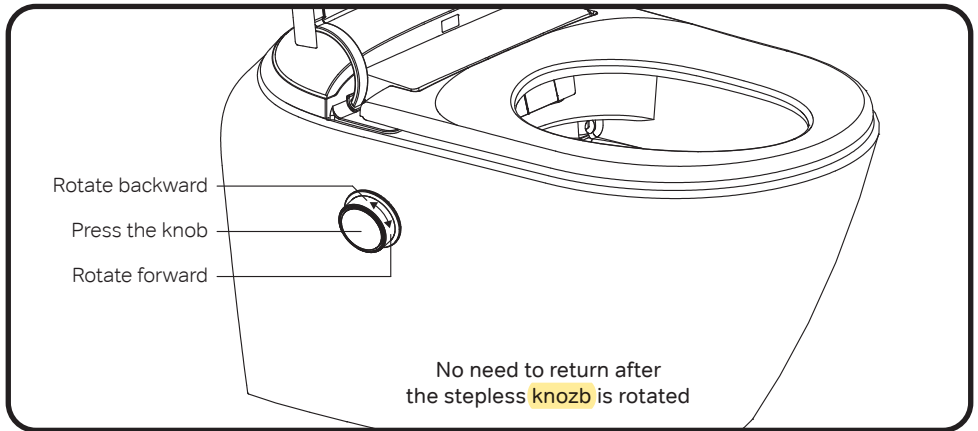

## Description of other functions

### **Auto flush (without the function for some models):**

After the user leaves the seat, it will automatically flush once.

### **Nozzle sterilization:**

After the user is away from the seat for 1 minute, the nozzle will automatically perform a deep ultraviolet sterilization for 2 minutes, and the sterilization will stop when it is seated again during the sterilization period.

### **Standby function (Sleep mode):**

Short press the "Standby/Descal" button on the fuselage to turn on or off the standby function. In the non-seated state and not in the descaling state, short press the "standby/descaling" button to turn off all the functions and lights and enter the standby state.

### **Automatic opening or closing of lid/seat:**

When a person approaches the ceramic sensing area, the upper cover automatically opens. When the upper cover is opened and the seat ring is closed, tap the ceramic induction area to open the seat. When the upper cover seat is open, touch the ceramic sensing area to close the cover and perform a flush (without the function for some models). After 90 seconds of non-functional operation and leaving the seat, the upper cover and seat are automatically closed in sequence. When the cover is closed for 5 seconds, the induction flip function works.

**Pipeline descaling (without the function for some models):** In the non-seated state, after adding descaling liquid, long press the "standby/descaling" button to turn on or off descaling. During descaling, the knob light is green breathing light. Please use a descaling agent whose main ingredients are food-grade citric acid and organic acid.

### **Dosage:**

Mix an appropriate amount (solid: 30-40g or liquid: 30-40ml) descaling agent with 50ml of water and stir until they are fully mixed or dissolved, and then pour the descaling solution from the product inlet. It is recommended to descale every 2-3 months.

**Rear wash:** Press the rear wash button and the nozzle extends, and then the rear wash starts.

**Bidet wash:** Press the bidet wash button and the nozzle will extend, and then the bidet wash starts.

**Drying:** Press the drying button to start drying.

**Stop:** Press the "Stop" button to stop the current function. When not seated, press and hold the "Stop" button for 5 seconds to turn on or off the ceramic ambient light.

**Deodorization:** When seated, the deodorization function starts. When the user leaves the seat, the deodorization function is turned off (press the "Deodorization" button to turn on or off the seated deodorization function).

**Massage cleaning:** In the state of rear wash or bidet wash, press the "Massage Cleaning" button on the remote control for the first time to start intermittent massage, and press the "Massage Cleaning" button again to start continuous massage, and finally press the "Massage Cleaning" button to close the massage cleaning.

**Oscillation:** In the state of rear wash or bidet wash, press the "Oscillation" button to turn on or off oscillation function. In the state of oscillation, press the "Spray arm forward" or "Spray arm backward" button to adjust the position.

**Flush (without the function for some models):** Press the "Flush" button to start flushing.

**Self-cleaning function:** Press the "Self-cleaning" button, the spray arm can be retracted back and forth, and clean it self.

**Ceramic sterilization:** In the off-seat state and the cover is closed, press the "Sterilization" button, the ultraviolet sterilization function is turned on (The knob light and the night light are both blue.) and lasts for 10 minutes. When the cover is opened, the sterilization stops. When the cover is closed, sterilization continues. The duration is not reset.

**Water volume adjustment:** During Rear/Bidet washing, each time you press the "rear" or "bidet" button to adjust the washing water volume accordingly, 3 levels can be adjusted, default setting in level 2.

**Seat temperature adjustment:** Every time you press the "seat temperature plus key", the seat temperature increases by one level. Every time you press the "seat temperature minus key", the seat temperature decreases by one level, and the three levels of addition and subtraction can be adjusted and turned off, and the corresponding gear indicator lights up separately.

**Air temperature adjustment:** Press the "dry" button to start drying. In the drying state, every time you press the button, the air temperature will be adjusted by one level, and 3 levels will be cyclically adjustable and closed.

**Water temperature adjustment:** During Rear/Bidet washing, each time you press the "water temperature" button, the water temperature is adjusted by one level, 3 levels can be cyclically adjusted and closed (long press the "water temperature" button to close), default setting in level 2, and the corresponding level indicator light is on.

**Nozzle position adjustment:**

Press the "Spray arm forward" or "Spray arm backward" button on the remote control, the nozzle moves forward or backward by one gear. Move to the limit position, and then press the "Spray arm forward" or "Spray arm backward" button, the nozzle does not move.

## Remote control instructions

**Cover flipping:** Press the "Cover flipping" button to control the opening and closing of the Lid.

**Seat flipping:** Press the "Seat flipping" button to control the opening and closing of the seat.

### **Eco mode:**

1. After pressing the "Energy Saving" button, the seat temperature will be automatically adjusted to the lowest level when the seat temperature is heated, and it will remain closed when the seat temperature heating is turned off.
2. In the energy-saving mode, all light displays are turned off.
3. In the energy-saving mode, the seating sensor detects that someone is seated, and automatically stops the energy-saving mode, and automatically enters the energy-saving mode after the user leaves the seat.
4. Press the "Energy Saving" button to turn on or off the energy saving mode function.
5. Ceramic ambient light: When not seated, press and hold the "Stop" button on the remote control for 5 seconds to turn on or off the ceramic ambient light.

**Night light function:** Control the night light on and off according to the light intensity of the bathroom through the light sensitivity of the toilet body. Short press the "night light" button to turn off the light-sensitive response function and long press the "night light" button to turn on the light-sensitive response function. The factory defaults to turn on the night light, short press the "night light" button to turn off or turn on the night light always-on function.

**Pipeline descaling ( without the function for some models):** In non-seated state, after adding descaling liquid, press the "Descaling" button to turn on or off descaling. During descaling, the knob light is green breathing light.

### **User 1/User 2 customization:**

Under the current use of "water temperature, water volume, spray arm position, air temperature", press and hold the "User 1 or User 2" button for more than 2 seconds, the current use setting can be set to the favorite custom button, and all the indicators on the remote control pane flashes twice, the settings you like have been saved. Press "User 1 or User 2" directly next time, and all gear indicators on the remote control panel will be on for one second. Press the rear wash or bidet wash button based on your need.

### **Combination button:**

Long press "Stop + Seat temperature plus" button to turn on or off the foot flushing function ( without the function for some models).

Long press the "Stop + Oscillation" button to turn on or off the sensor flip-up function.

Long press the "Stop + Massage cleaning" button to turn on or off the function of opening or closing the lid by foot sensor.

Long press the "Stop + cover flipping" button to turn on or off the automatic function of closing the cover and the seat.



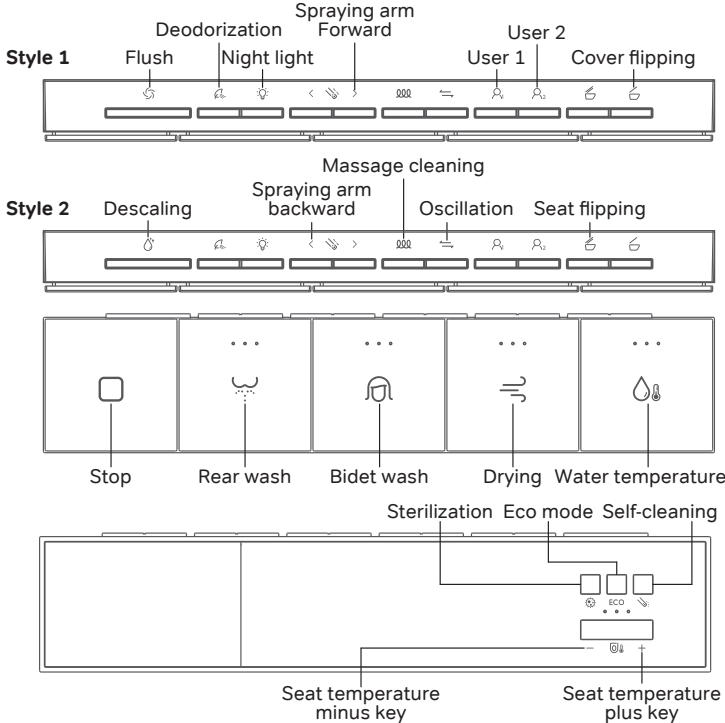

**Code matching:**

Press and hold the "Bidet wash + Drying" button at the same time for 5 seconds to enter the code matching mode. The lights on the rear wash, bidet wash, drying and water temperature buttons flash. In the code-matching mode, press the "Water temp." button to select the corresponding user code, lights of which will light up in sequence from left to right. After selecting the user code, press the "Stop" key to complete the code matching operation.

**Troubleshooting and alarm repair**

- The temperature of the inlet water is abnormal: the red light on the knob flashes once.
- Abnormal water temperature: the red light on the knob flashes twice.
- Abnormal air temperature: the red light on the knob flashes 3 times.
- Abnormal heating temperature of the seat : the red light on the knob flashes 5 times.
- The drying fan is abnormal: the red light on the knob flashes 7 times.







